

# INSTALLATION INSTRUCTIONS

# INTERNALLY OR EXTERNALLY BRACED WIND DRIVEN TURBINE WITH BASE AND RISER

## SELECTING THE LOCATION:

**MATERIALS NEEDED:**  
Roofing Nails  
Roofing Cement or Caulking

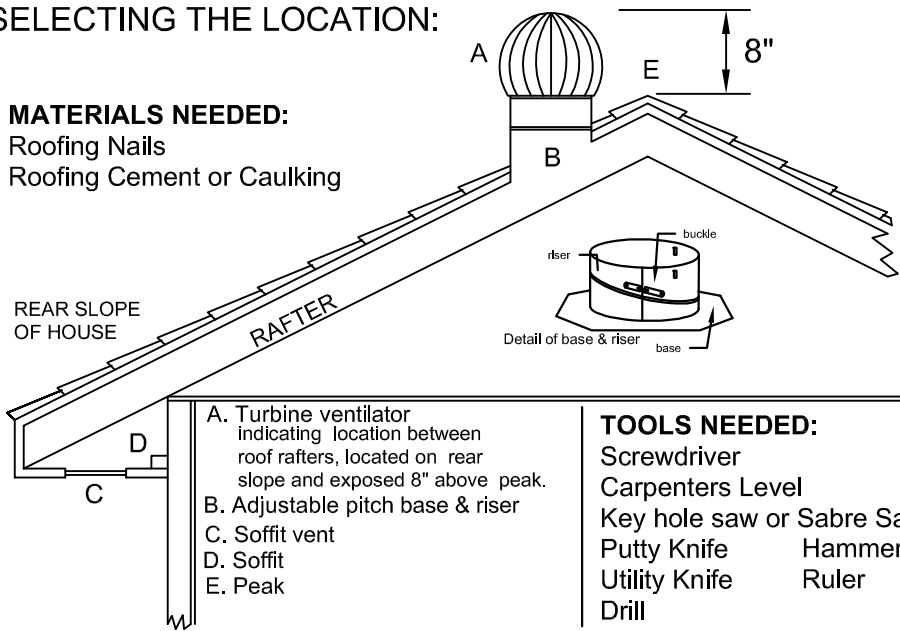

- A. Turbine ventilator indicating location between roof rafters, located on rear slope and exposed 8" above peak.
- B. Adjustable pitch base & riser
- C. Soffit vent
- D. Soffit
- E. Peak

**TOOLS NEEDED:**  
Screwdriver  
Carpenters Level  
Key hole saw or Sabre Saw  
Putty Knife  
Utility Knife  
Drill  
Hammer  
Ruler

## DETERMINE SPACING WHEN MORE THAN ONE TURBINE IS REQUIRED

Turbine is best located on rear slope with top rising 8" above roof peak, to allow turbine top to be exposed to wind from all directions. When installing two units, place one 1/4 the distance from each end of house. For three units, place one in center and remaining two 1/6 the distance from each end of house.

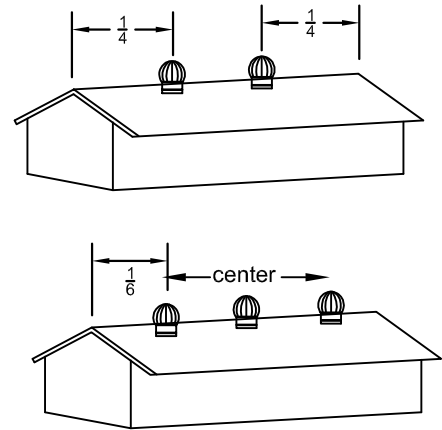

## STEP #1 DETERMINE LOCATION

From inside of attic, locate a spot directly between two rafters at approximate distance down from peak where turbine should be located. Drill a hole through the roof to be used as the center reference for step 2.

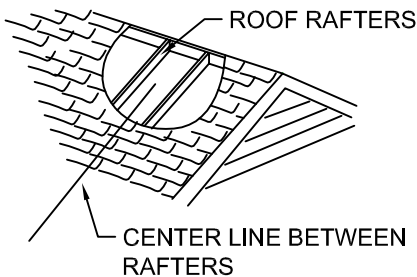

## STEP #2 MARK & CUT HOLE

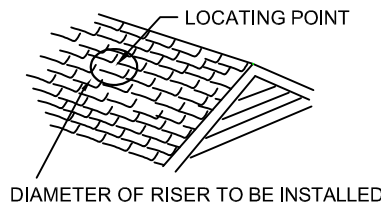

Locate reference hole (step 1) on outside of roof. Using this hole as center, draw a 12" circle (for 12" models) or a 14" circle (for 14" models) on roof sheeting. Cut around circumference of circle.

**FOR INFORMATION OR ASSISTANCE WITH INSTALLATION CALL 1-800-433-1626 BETWEEN 10 A.M. AND 3 P.M. CENTRAL TIME**

## STEP #3 ADJUST & LEVEL THE RISER

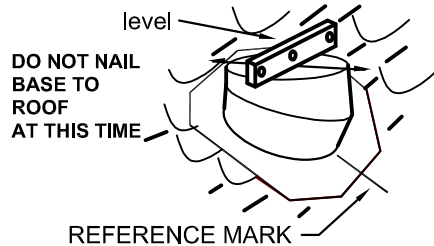

Place base & riser on roof, rotate base/riser until top of riser is level. It may be necessary to rotate base in conjunction with riser to achieve level on top. Depending on slope of roof, it is possible that the hexagon shape of base may not line up with roof shingles. Once top of base/riser is level, make a reference mark on bottom of unit (this will be used in step 5 when securing turbine to roof).

## STEP #4 ATTACH TURBINE TO RISER

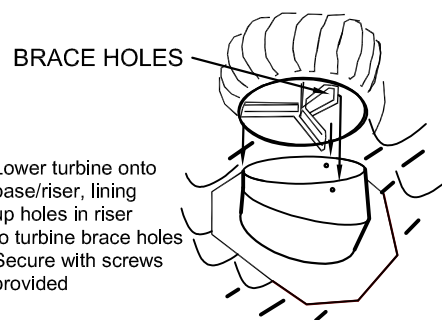

Lower turbine onto base/riser, lining up holes in riser to turbine brace holes. Secure with screws provided.

For externally braced units, secure external brace to top hole in turbine brace.

## STEP #5 ATTACH THE TURBINE

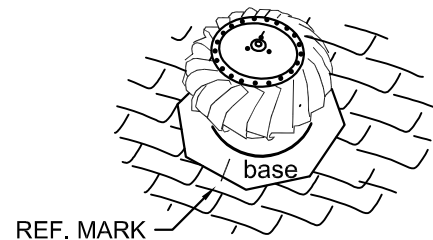

Slide base under shingles as shown above, removing interfering fasteners. Ensure that reference mark (step 3) is facing down. Slide turbine out. Apply a liberal amount of roofing cement under base. Replace turbine under shingles and secure with roofing nails or screws. Seal seams and nails with roofing cement.