

Description

The NuVent PF Series fans feature a permanently lubricated, high performance motor and a unique Quick-Lock mounting bracket to allow for easy installation. A one-piece molded housing assures quiet operation. Ideal for use in bathrooms, powder rooms, utility areas and rec rooms.

Features

Grille

- Textured, white polymeric.
- Mounts directly to housing with torsion springs.

Housing

- One-piece molded plastic.
- Extended discharge collar for easy attachment to 4" diameter duct.
- Quick-Lock mounting bracket for right or left ducting.
- Removable electrical cover and knockouts on side and top of housing for easy wiring.
- Large removable wiring compartment.

Blower

- Built-in backdraft damper.
- Removable blower with easy slide-in mounting
- Plug in motor rated for 120 volts 60 Hz operation.

Other

- Permanently lubricated, shaded pole motor.
- This product is approved for use over tub/shower enclosures when installed in a GFI protected branch circuit.

Performance

- Air Delivery – 90 CFM @ .1" w.g. s.p.
- Sound Level - 3.0 sones
- Volts - 120
- Hertz - 60
- Amps – .55
- Watts – 47
- Duct - 4" round



The Home Ventilating Institute has tested and certified the airflow performance (CFM) and sound levels (sones) of this product.

General

This product has been evaluated by Underwriters Laboratories and conforms to both UL and CSA safety standards.



Specifications

NuVent ventilator model PF90. The ventilator shall be constructed with a one-piece molded plastic housing including Quick-Lock mounting bracket and 4" diameter discharge collar. The blower unit shall be removable with a plug-in motor. Air delivery and sound levels shall be certified by HVI at the levels listed for this model. All units shall be UL listed.

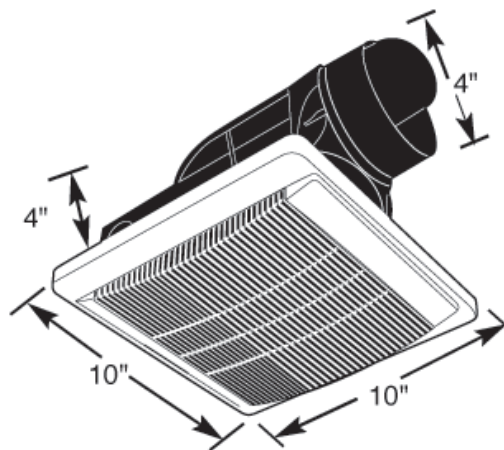

NuVent Product Performance
Model NXPF90

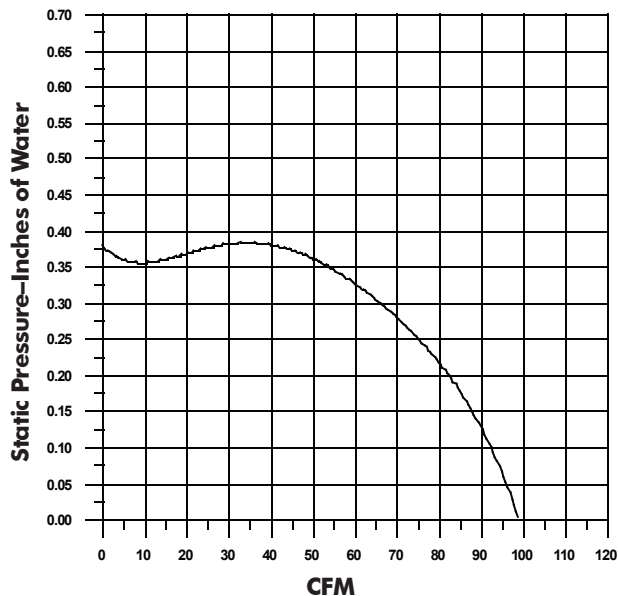

SPECIFICATION			PROJECT:
Reference	Quantity	Comments	Location:
			Architect:
			Engineer:
			Contractor:
			Submitted by:
			Date: